

High-Reliability Power Inductors

ML515PMM
ML515PMD

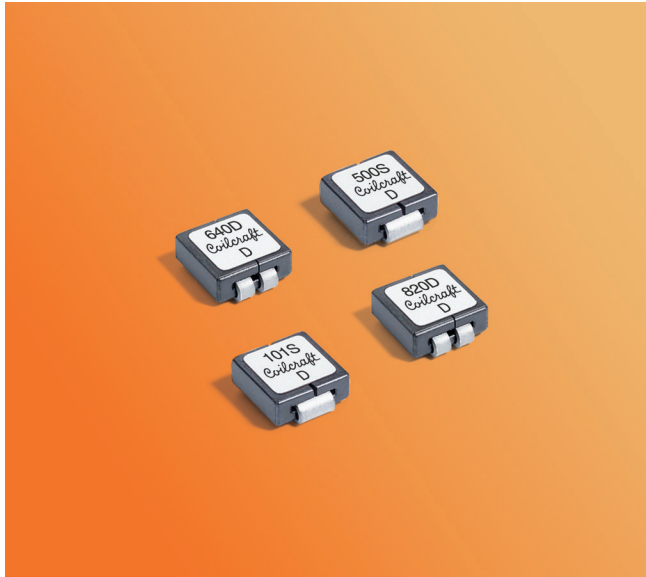

- Designed for high-speed switch mode applications
- Can be used as 1:1 transformers or in SEPIC applications

Core material Ferrite

Terminations Matte tin over nickel over copper.

Weight 0.44 – 0.47 g

Ambient temperature –55°C to +125°C with Irms current

Maximum part temperature +155°C (ambient + temp rise).

Storage temperature Component: –55°C to +155°C.

Tape and reel packaging: –40°C to +80°C

Resistance to soldering heat Max three 40 second reflows at +260°C, parts cooled to room temperature between cycles

Moisture Sensitivity Level (MSL) 1 (unlimited floor life at <30°C / 85% relative humidity)

Packaging 500/7" reel; Plastic tape: 16 mm wide, 0.33 mm thick, 12 mm pocket spacing, 3.12 mm pocket depth

Single Conductor

Part number ^{1,7}	L±20% ² (µH)	DCR ±5% ³ (mOhms)	SRF ref ⁴ (GHz)	Isat ⁵ (A)	Irms ⁶ (A)
ML515PMM500MLZ	0.050	0.123	3.80	50	40
ML515PMM640MLZ	0.064	0.123	3.65	32	40
ML515PMM820MLZ	0.082	0.123	3.75	22	40
ML515PMM101MLZ	0.100	0.123	3.75	20	40

Dual Conductor

Leads connected in parallel

Leads connected in series

Part number ¹	L±20% ² (µH)	DCR ±5% ³ (mOhms)	SRF ref ⁴ (GHz)	Isat ⁵ (A)	Irms ⁶ (A)	L±20% ² (µH)	DCR max ³ (mOhms)	SRF ref ⁴ (GHz)	Isat ⁵ (A)	Irms ⁶ (A)
ML515PMD500MLZ	0.050	0.209	3.75	50	38	0.188	1.00	1.50	21	17
ML515PMD640MLZ	0.064	0.209	3.65	32	38	0.272	1.00	1.30	14	17
ML515PMD820MLZ	0.082	0.209	3.75	22	38	0.350	1.00	1.20	11	17
ML515PMD101MLZ	0.100	0.209	3.75	20	38	0.400	1.00	0.950	8	17

1. When ordering, specify **conductors** and **screening** codes:

ML515PMD101MLZ

Conductors: M = Single conductor; D = dual conductor

Screening: Z = Unscreened

Y = Unscreened (SLDC Option A)

W = Unscreened (SLDC Option B)

H = Group A screening per Coilcraft CP-SA-10001

G = Coilcraft CP-SA-10001 Group A (SLDC Option A)

D = Coilcraft CP-SA-10001 Group A (SLDC Option B)

1/2/3 = EEE-INST-002 (Family 1) Level 1/2/3

4/5 = MIL-STD-981 (Family 04) Class B=4, Class S=5

F = Screening per ESCC 3201

- Screening performed to the document's latest revision.
- Lot qualification (Group B) available.
- Custom testing also available.

2. Inductance tested at 100 kHz, 0.1 Vrms using an Agilent/HP 4263B LCR meter or equivalent.

3. DCR is measured on a micro-ohmmeter at points indicated in the diagram.



▲ Points used for measuring DCR

4. This information is for design purposes only and shall not be tested during screening.

5. DC current at 25±C that causes an inductance drops of 20% (typ) from its value without current.

6. Current that causes a 40°C rise from 25°C ambient. This information is for reference only and does not represent absolute maximum ratings.

7. Due to the design of this component, DWV and IR shall not be specified or tested.

8. Electrical specifications at 25°C.

Refer to Doc 362 "Soldering Surface Mount Components" before soldering.

Coilcraft CPS
CRITICAL PRODUCTS & SERVICES

1102 Silver Lake Road
Cary, IL 60013
Phone 800-981-0363

© Coilcraft, Inc. 2023

Fax 847-639-1508
Email cps@coilcraft.com
www.coilcraft-cps.com

Document ML366-1 Revised 08/11/23

This product may not be used in medical or high risk applications without prior Coilcraft approval. Specifications subject to change without notice. Please check our web site for latest information.

High-Reliability Power Inductors – ML515PMM & PMD

Typical L vs Current

Single Conductor

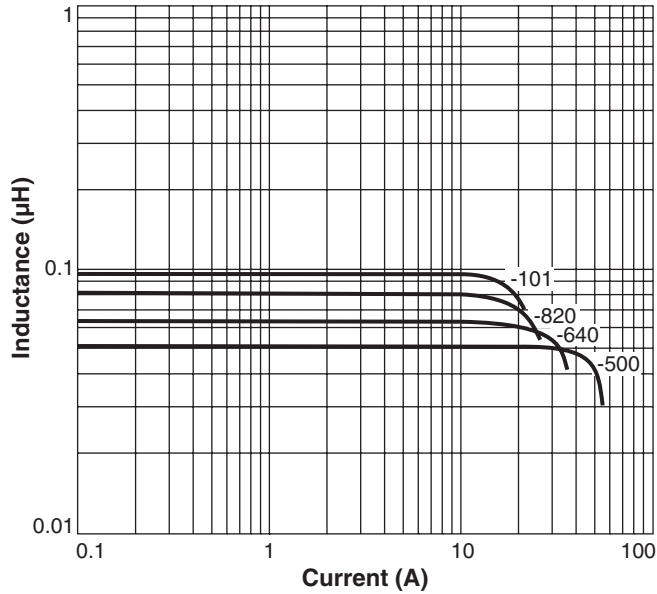

Dual Conductor

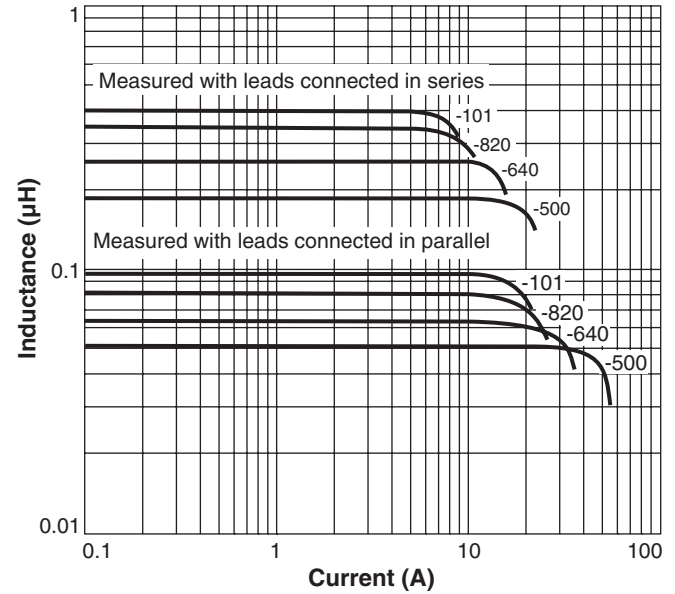

Typical L vs Frequency

Single Conductor

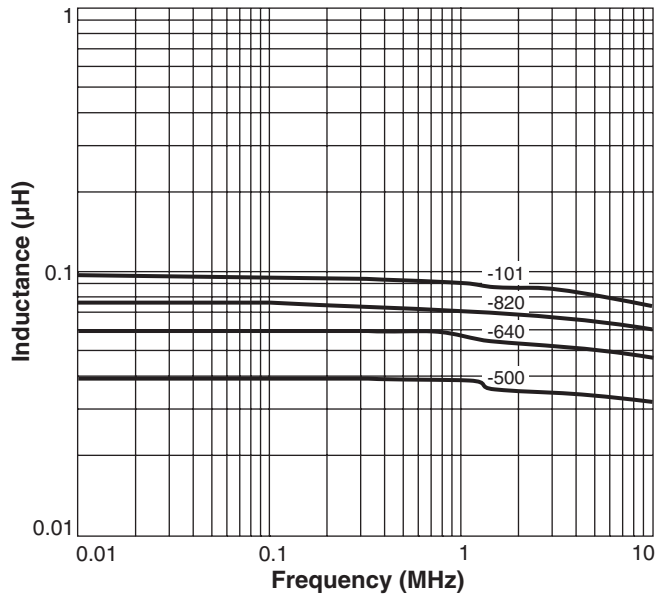

Dual Conductor

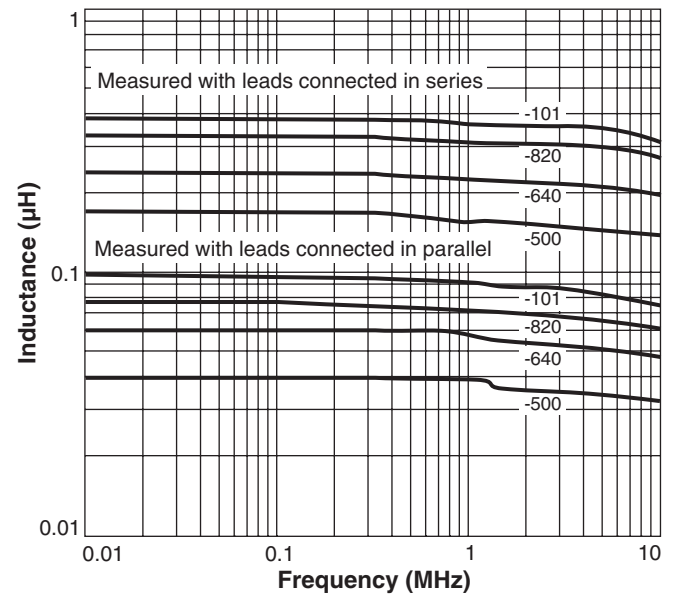

SPICE models
ON OUR WEB SITE



1102 Silver Lake Road
Cary, IL 60013
Phone 800-981-0363

Fax 847-639-1508
Email cps@coilcraft.com
www.coilcraft-cps.com

Document ML366-2 Revised 08/11/23

This product may not be used in medical or high risk applications without prior Coilcraft approval. Specifications subject to change without notice. Please check our web site for latest information.

High-Reliability Power Inductors – ML515PMM & PMD

Typical Temperature Rise vs Current

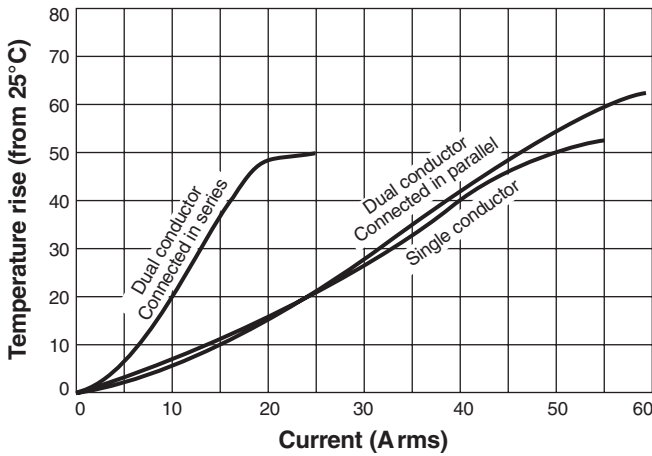

Current Derating

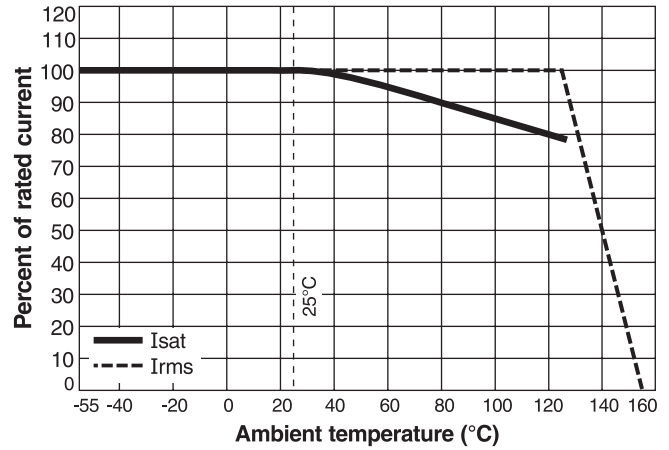

Dimensions – Single Conductor

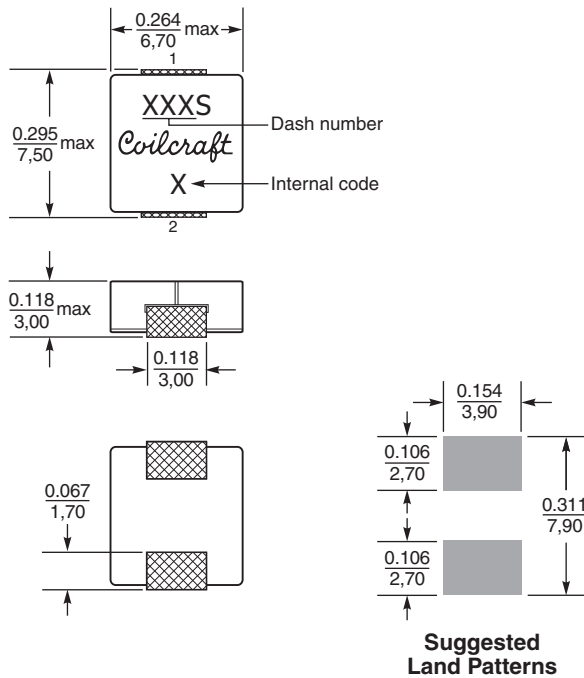

Note: Dimensions are before optional solder application. For maximum overall dimensions including solder, add 0.0025 in / 0,064 mm to the length, and 0.006 in / 0,15 mm to the height.

Dimensions are in $\frac{\text{inches}}{\text{mm}}$

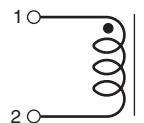

Dimensions – Dual Conductor

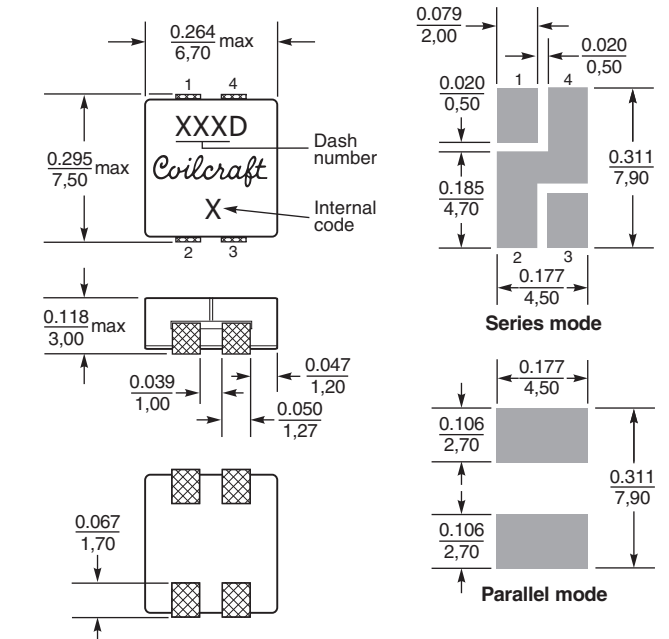

Note: Dimensions are before optional solder application. For maximum overall dimensions including solder, add 0.0025 in / 0,064 mm to the length, and 0.006 in / 0,15 mm to the height.

Dimensions are in $\frac{\text{inches}}{\text{mm}}$

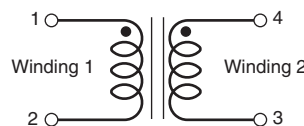

Winding-to-winding isolation:
25 V maximum

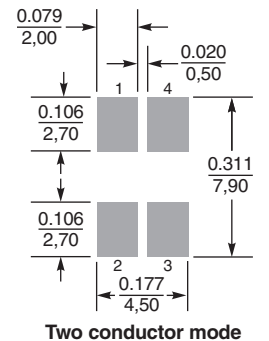

Suggested Land Patterns



CRITICAL PRODUCTS & SERVICES

© Coilcraft, Inc. 2023

1102 Silver Lake Road
Cary, IL 60013
Phone 800-981-0363

Fax 847-639-1508
Email cps@coilcraft.com
www.coilcraft-cps.com

Document ML366-3 Revised 08/11/23

This product may not be used in medical or high risk applications without prior Coilcraft approval. Specifications subject to change without notice. Please check our web site for latest information.